

PRODUCT NO.  
SEE TABLE

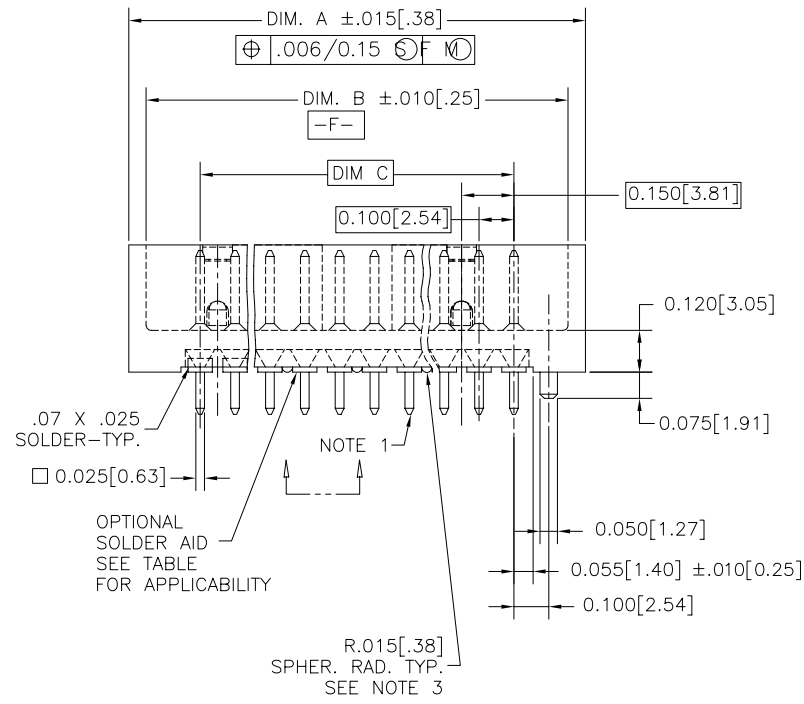

SECTION Y-Y

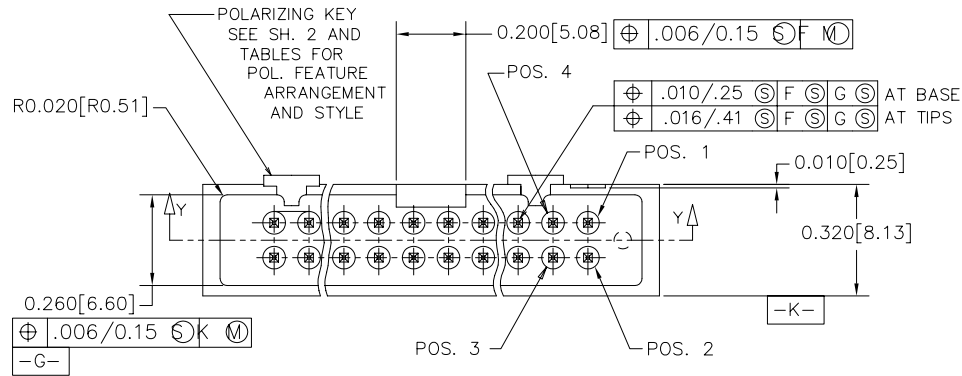
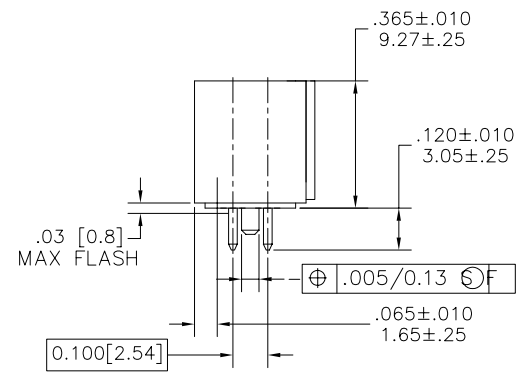
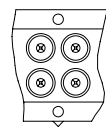

mat'l. code		surface		tolerance		projection		product family	
SEE NOTES		ISO 1302 ✓		ISO 406 ISO 1101				HEADER	
ltr	ecn	no	dr	date	tolerances unless otherwise specified		title		
F	V11471	MRC	7/2/91		angles	.XX±.01/.3	DU FLO 4 WALL		
G	T10177	MRC	8/28/91		linear	.XXX±.005/.13	SLIM-LINE HEADER, KEYED		
H	V71134	SAR	10/28/97	0°±2'	.XXXX±.0020/.051		scale 1:1		
J	V80083	LSS	1/28/98	dr	J.W. BAIR	3/3/90	dwg no		
K	V80264	SAR	2/12/98	enr	M. SMYK	3/3/90	sheet 1 of 3 size		
L	M05-0167	ERE	7/23/05	chr	M. SMYK	3/30/90	78283 A3		
M	M07-0116	AGS	2/25/07	appd	M. SMYK	3/30/90	type Product Customer Drawing		
sheet	revision	M	M	M					
index	sheet	1	2	3					

FCI  
FCIconnect.com

Copyright FCI

PRODUCT NO. SEE TABLE		KEY FOR PLATING AND OPTIONS				
X	TERMINAL PLATING	RETENTION	SOLDER AID NOTE (6)	POLARIZING KEY	NOTE	
-0XX	30μ"/.76μm Au OVER 50μ"/1.27μm Ni	YES	YES	YES	9	
-1XX	30μ"/.76μm GXT	YES	YES	YES	9	
-2XX	30μ"/.76μm Au OVER 50μ"/1.27μm Ni	NO	NO	YES	-	
-3XX	30μ"/.76μm GXT	NO	NO	YES	-	
-4XX	30μ"/.76μm Au OVER 50μ"/1.27μm Ni	YES	NO	YES	9	
-5XX	30μ"/.76μm GXT	YES	NO	YES	9	
-6XX	15μ"/.38μm GXT	YES	NO	NO	9	
-7XX	30μ"/.76μm GXT	YES	NO	NO	-	
-8XX	15μ"/.38μm GXT	YES NOTE 8	NO	NO	9 & 10	

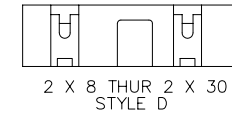
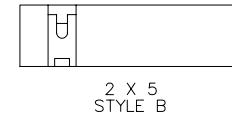
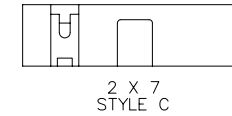
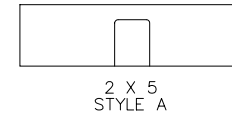

NOTES:

- ① SAME PIN POSITION TOLERANCE APPLIES TO BOTH ENDS OF EACH TERMINAL.
- ② MOLDING MAT'L: GLASS-FILLED POLYESTER, FLAME RETARDANT PER UL-94V-0, COLOR: BLUE
3. 1° MAX DRAFT PERMISSIBLE ON ALL SURFACES.
4. 4 POUNDS/1.8 KILOGRAMS MIN TERMINAL PULL-OUT FORCE.
5. TERMINAL MAT'L: PHOSPHOR BRONZE.
- ⑥ SOLDER AID COMPOSITION 60/40 WITH RMA FLUX.
- ⑦ 15 POUNDS / 6.8 KILOGRAMS MAX INSERTION FORCE AND .5 POUNDS / 2.26 KILOGRAMS MIN RETENTION FORCE USING .062/1.57 THICK CIRCUIT BOARDS AND RECOMMENDED HOLE PATTERN.
- ⑧ ONLY A SINGLE PAIR OF PINS TO HAVE RETENTION IN CENTER AREA OF -8XX HEADERS.
- ⑨ MOLDED IN KEYS ARE MANUFACTURER'S OPTION.
10. PRODUCT WITH 'C' AT THE END ARE MADE IN USA. PINS ARE INSERTED INTO PLASTIC HOUSING. (EX.-78283-816C 2X8 MADE IN USA).
- ⑪ ADD "LF" SUFFIX AT THE END OF PART NUMBER FOR LEAD FREE OPTION
- ⑫ THIS PRODUCT MEETS EUROPEAN UNION DIRECTIVES AND OTHER COUNTRY REGULATION AS DESCRIBED IN GS-22-008.
13. THE HOUSING WILL WITHSTAND EXPOSURE TO 260°C PEAK TEMPERATURE FOR 15 SECONDS IN A WAVE SOLDER APPLICATION WITH A 1.5mm MINIMUM THICK CIRCUIT BOARD. SEE APPLICATION NOTES/PROCEDURES IF THEY ARE AVAILABLE.

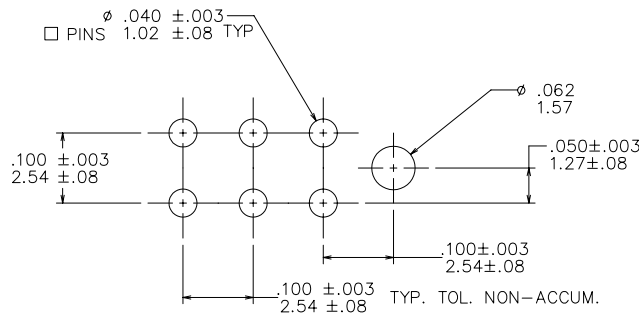

RECOMMENDED HOLE PATTERN  
SCALE 10/1

mat'l. code SEE NOTES		surface ISO 1302 ✓	tolerance ISO 406 ISO 1101	projection INCH/MM	product family HEADER
ltr	ecn no/dr	date		tolerances unless otherwise specified	title
M	SAR	angles	linear .XX±.01/.3	INCH/MM	DU FLO 4 WALL
		0°±2'	.XXX±.005/.13	scale 1:1	SLIM-LINE HEADER, KEYED
		dr	J.W. BAIR 3/3/90		dwg no
		enr	M. SMYK 3/3/90		sheet 2 of 3
		chr	M. SMYK 3/30/90		size
		appd	M. SMYK 3/30/90		A3
sheet index	revision sheet				type Product Customer Drawing

PRODUCT NO. NOTE 11	DIM 'A'	DIM 'B'	DIM 'C'	STYLE
78283-X09	.780[19.81]	.720[18.29]	.400[10.16]	A
↑ -X10	.780[19.81]	.720[18.29]	.400[10.16]	B
-X14	.980[24.89]	.920[23.37]	.600[15.24]	C
-X16	1.080[27.43]	1.020[25.91]	.700[17.78]	D
-X20	1.280[32.51]	1.220[30.99]	.900[22.86]	↑
-X24	1.480[37.59]	1.320[33.53]	1.100[27.94]	
-X26	1.580[40.13]	1.520[38.61]	1.200[30.48]	
-X30	1.780[45.21]	1.720[43.69]	1.400[35.56]	
-X34	1.980[50.29]	1.920[48.77]	1.600[40.64]	
-X36	2.080[52.83]	2.020[51.31]	1.700[43.18]	
-X40	2.280[57.91]	2.220[56.39]	1.900[48.26]	
-X44	2.480[62.99]	2.420[61.47]	2.100[53.34]	
↓ -X50	2.780[70.61]	2.720[69.09]	2.400[60.96]	
78283-X60	3.280[83.31]	3.220[81.79]	2.900[73.66]	D



Copyright FCI

mat'l. code		surface		tolerance		projection		product family	
SEE NOTES		ISO 1302 ✓		ISO 406 ISO 1101				HEADER	
ltr	ecn no	dr	date	tolerances unless otherwise specified		INCH/MM		title	
M				angles	linear	.XX±.01/.3 .XXX±.005/.13 .XXXX±.0020/.051		DU FLO 4 WALL SLIM-LINE HEADER, KEYED	
				0°±2'		scale 1:1		dwg no 78283 sheet 3 of 3 size A3	
		dr	J.W. BAIR	3/3/90				type Product Customer Drawing	
		enr	M. SMYK	3/3/90					
		chr	M. SMYK	3/30/90					
		appd	M. SMYK	3/30/90					
sheet index	revision sheet								